

Altea versions 90-120 book and sofa, is a transformable system with a single or large single bed with a patented slatted base, and folding opening.

Available in the following sizes

Altea 90-120:	H. 2200 mm.	L. 1010-1310 mm.	D. 350 mm.
Altea Book:	H. 2200 mm.	L. 1010-1310 mm.	D. 623 mm.
Altea Sofa 90-120			
sofa size:	L. 900-1200 mm.	H. seat 390 mm.	D.850 mm.

Altea Book is equipped with a cushions container and shelves.

Altea Sofa, the patented sofa with tilting structure and translatory movement totally disappears when you open the bed

Altea 90-120 and Book must be fixed to the wall.

Altea Sofa is self-supporting.

TECHNICAL INFORMATION

Wooden **frame** with adjustable nylon feet.

Opening **mechanism** attached to the frame with an articulation system through gas pistons.

Bed base CF09. The invention relates to a bed base with automatic locking mechanism in the vertical or horizontal position, which prevents accidental opening and closing, and fixing the facade finishing without the need for hardware.

Features and advantages over the standard serial bed base:

- The safety is guaranteed by the innovative locking system of the bed base by means of a pin which is engaged automatically. (fig 1)
- Opening and closing the bed base are performed by a simple movement through the device inserted into the foot (fig. 2)
- The frame and aesthetics of the facade are the result of innovative technologies: soft lines with thicknesses of the artefact with no handles to prevent compromising the aesthetic cleanliness in the panel/network joint, with the opening mechanism hidden in the side gaps (fig. 3-4).

Maximum **capacity** table top 50 kg.

Maximum bed **capacity** 150 kg.

Available mattress : in compliance with UK fire regulation

Mattress **locking belts** in nylon with fasteners.

Standard finish: white melamine dover, melamine whited/graphite oak, embossed laquer in cleicoloursystem variants

Facade: white melamine dover, melamine whited/graphite oak, embossed laquer in cleicoloursystem variants, glossy dialux, lacquered decorations and print as per the Pattern and Decor\Pattern folder.

Applicable prints: Scot, Quadra, Petal and Bubble

Backs: white melamine. Lacquered on request

WARNINGS: ASSEMBLY AND SAFETY

- The products are delivered unassembled and assisted by specific assembly instructions.

- It is mandatory to anchor the walls' product and intact and strong walls, with 4 mounting points resting on perfectly level floor (except for Altea sofa models).

In the hardware supplied, there are also a number of plugs that can be used exclusively for fixing the product on walls and solid concrete panels R250 (see specific assembly instructions). In any case, the choice of hardware suitable to fasten the product is at the sole responsibility of the installer who has to check the integrity and the wall/panel's degree of resistance where to install the product and is also responsible for state-of-the-art assembly, fixing and testing of the product.

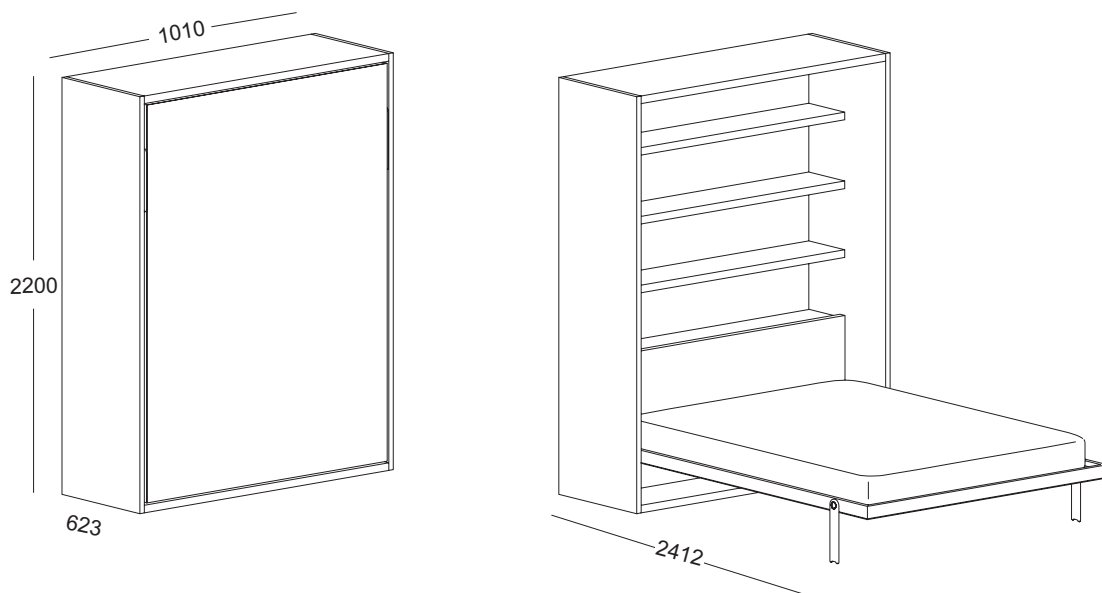

Details of the patented bed base CF09

Fig. 1

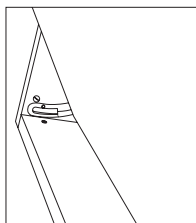

Fig. 2

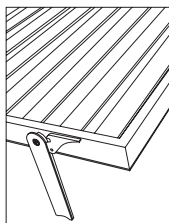

Fig. 3

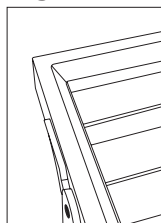
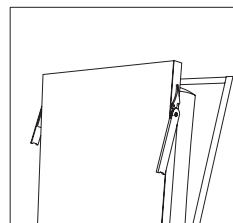

Fig. 4



ALTEA 90 with bed base CF09

Maximum dimensions for all versions: mattress 1970 x 850 x 180 mm, height bed spring from the ground 336.5 mm.

Sofa version: sofa seat depth 850 mm, sofa seat height from the ground 376 mm, armrest height 500 mm.

NB: prices are exclusive of mattress and upholstered headboard.

PRINTING: for combinations see decorations page.

ALTEA 90.35

Vertical tilting single bed

THIS MODEL MUST BE FIXED TO THE WALL

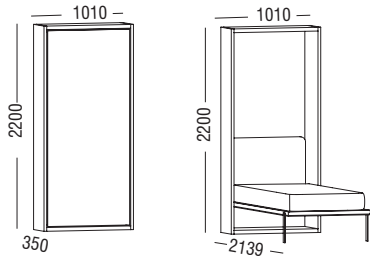

ALTEA 90 SOFA

Vertical tilting single bed with front stuffed bench

Required fabric to upholster the sofa mt. 4.5

SELF STANDING SYSTEM

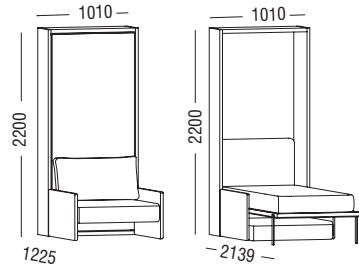

ALTEA BOOK 90

Vertical tilting single bed with inner storage for pillow and shelves on the back panel

THIS MODEL MUST BE FIXED TO THE WALL

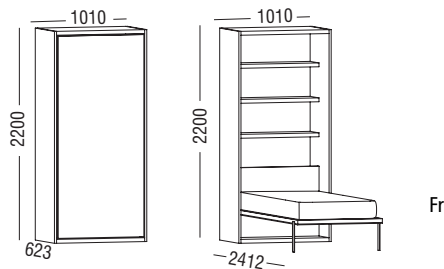

ALTEA BOOK 90 SOFA

Vertical tilting single bed with inner storage for pillow and shelves on the back panel

Required fabric to upholster the sofa mt. 4.5

SELF STANDING SYSTEM

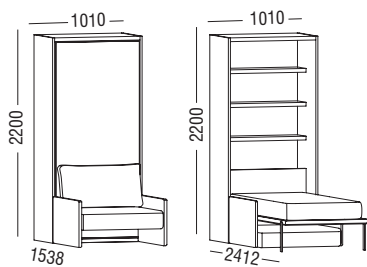

ALTEA 120 with bed base CF09

Maximum dimensions for all versions: mattress 1970 x 1150 x 180 mm, height bed spring from the ground 336.5 mm.

Sofa version: sofa seat depth 850 mm, sofa seat height from the ground 376 mm, armrest height 500 mm.

NB: prices are exclusive of mattress and upholstered headboard.

PRINTING: for combinations see decorations page.

ALTEA 120.35

Vertical tilting intermediate bed

THIS MODEL MUST BE FIXED TO THE WALL

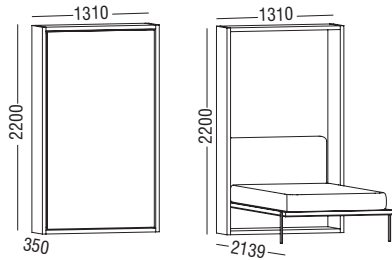

ALTEA 120 SOFA

Vertical tilting intermediate bed with front stuffed bench

Required fabric to upholster the sofa mt. 5

SELF STANDING SYSTEM

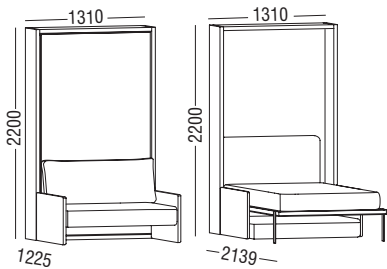

ALTEA BOOK 120

Vertical tilting intermediate bed with inner storage for pillow and shelves on the back panel

THIS MODEL MUST BE FIXED TO THE WALL

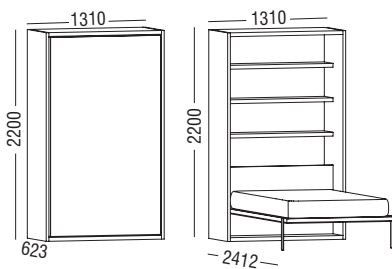

ALTEA BOOK 120 SOFA

Vertical tilting intermediate bed with inner storage for pillow and shelves on the back panel

Required fabric to upholster the sofa mt. 5

SELF STANDING SYSTEM

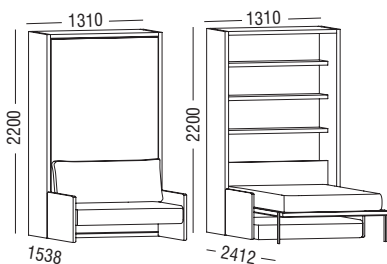

DECORATIONS ALTEA 90 AND 120 - BOOK/SOFA



PRINTINGS:

Version **Quadra, Bubble, Petalo e Scot.**

Decoration is on a lacquered white cover having the cleicoloursystem in color samples excluding Onyx and Aluminum in the combinations shown in the Pattern and Decor\Pattern folders.

No changes may be made to the combinations in the Pattern folder.

The prints vary depending on the size of the panel, therefore, the indications provided in the specific folders are indicative only.

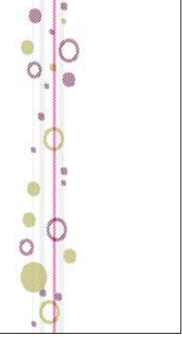
	Designation	Specifications		
<p>QUADRA</p> 	<p>QUADRA</p>	<p>ALTEA 90</p> <p>ALTEA 120</p>		
<p>SCOT</p> 	<p>SCOT</p>	<p>ALTEA 90</p> <p>ALTEA 120</p>		
<p>PETALO: (L/R)</p> 	<p>PETALO</p>	<p>Always specify if right or left side</p> <p>ALTEA 90</p> <p>ALTEA 120</p>		
<p>BUBBLE: (L/R)</p> 	<p>BUBBLE</p>	<p>Always specify if right or left side</p> <p>ALTEA 90</p> <p>ALTEA 120</p>		

TEXTILE AND ACCESSORIES FOR ALTEA 90 AND 120

The items listed below are accessory parts for all Altea models. Each specifies if there are exceptions for use.

Description	Dimens.	Finishes		
Altea 90 Stuffed single headboard (not for Altea Book)	Required fabric mt.1,40 in W.140 cm.	Fabric cat. 1 Fabric cat. 2 Customer fabric		
Altea 120 Stuffed Intermediate headboard (not for Altea Book)	Required fabric mt.1,60 in W.140 cm.	Fabric cat. 1 Fabric cat. 2 Customer fabric		
Altea 90 Single bedspread (with elastics on corners)	Required fabric mt. 3 in H. 140	Fabric cat. 1 Fabric cat. 2 Customer fabric		
Altea 120 Intermediate bedspread not for Altea Book	Required fabric mt. 5 in H. 140	Fabric cat. 1 Fabric cat. 2 Customer fabric		
Cushion in foam	30 x 30	Fabric cat. 1 Fabric cat. 2 Customer fabric		
Altea 90 single mattress	H. 1970 - W. 850 - Th. 180	Spring mattress		
Altea 120 Intermediate mattress	H. 1970 - W. 1150 - Th. 180	Spring mattress		
LED LIGHTING : 1 led, with warm light, inserted in the side panel Equipped with sensor switch 	mm. 280x30	Always specify if right or left side		